

SKKT 106, SKKT 106B, SKKH 106



SEMIPACK® 1

Thyristor / Diode Modules

SKKT 106

SKKT 106B

SKKH 106

Features

- Heat transfer through aluminium oxide ceramic isolated metal baseplate
- Hard soldered joints for high reliability
- UL recognized, file no. E 63 532

Typical Applications*

- DC motor control (e. g. for machine tools)
- AC motor soft starters
- Temperature control (e. g. for ovens, chemical processes)
- Professional light dimming (studios, theaters)

1) See the assembly instructions

V_{RSM} V	V_{RRM}, V_{DRM} V	$I_{TRMS} = 180$ A (maximum value for continuous operation) $I_{TAV} = 106$ A (sin. 180; $T_c = 85$ °C)		
900	800	SKKT 106/08E	SKKT 106B08E	SKKH 106/08E
1300	1200	SKKT 106/12E	SKKT 106B12E	SKKH 106/12E
1500	1400	SKKT 106/14E	SKKT 106B14E	SKKH 106/14E
1700	1600	SKKT 106/16E	SKKT 106B16E	SKKH 106/16E
1900	1800	SKKT 106/18E	SKKT 106B18E	SKKH 106/18E

Symbol	Conditions	Values	Units
I_{TAV}	sin. 180; $T_c = 85$ (100) °C;	106 (78)	A
I_D	P3/180F; $T_a = 35$ °C; B2 / B6	145 / 180	A
	P16/200F; $T_a = 35$ °C; B2 / B6	190 / 260	A
I_{RMS}	P3/180F; $T_a = 35$ °C; W1 / W3	200 / 3 * 140	A
I_{TSM}	$T_{vj} = 25$ °C; 10 ms	2250	A
	$T_{vj} = 130$ °C; 10 ms	1900	A
i^2t	$T_{vj} = 25$ °C; 8,3 ... 10 ms	25000	A²s
	$T_{vj} = 130$ °C; 8,3 ... 10 ms	18000	A²s
V_T	$T_{vj} = 25$ °C; $I_T = 300$ A	max. 1,65	V
$V_{T(TO)}$	$T_{vj} = 130$ °C	max. 0,9	V
r_T	$T_{vj} = 130$ °C	max. 2	mΩ
$I_{DD}; I_{RD}$	$T_{vj} = 130$ °C; $V_{RD} = V_{RRM}; V_{DD} = V_{DRM}$	max. 20	mA
t_{gd}	$T_{vj} = 25$ °C; $I_G = 1$ A; $di_G/dt = 1$ A/μs	1	μs
t_{gr}	$V_D = 0,67 * V_{DRM}$	2	μs
$(di/dt)_{cr}$	$T_{vj} = 130$ °C	max. 150	A/μs
$(dv/dt)_{cr}$	$T_{vj} = 130$ °C	max. 1000	V/μs
t_q	$T_{vj} = 130$ °C	100	μs
I_H	$T_{vj} = 25$ °C; typ. / max.	150 / 250	mA
I_L	$T_{vj} = 25$ °C; $R_G = 33$ Ω; typ. / max.	300 / 600	mA
V_{GT}	$T_{vj} = 25$ °C; d.c.	min. 3	V
I_{GT}	$T_{vj} = 25$ °C; d.c.	min. 150	mA
V_{GD}	$T_{vj} = 130$ °C; d.c.	max. 0,25	V
I_{GD}	$T_{vj} = 130$ °C; d.c.	max. 6	mA
$R_{th(j-c)}$	cont.; per thyristor / per module	0,28 / 0,14	K/W
	sin. 180; per thyristor / per module	0,3 / 0,15	K/W
	rec. 120; per thyristor / per module	0,32 / 0,16	K/W
$R_{th(c-s)}$	per thyristor / per module	0,2 / 0,1	K/W
T_{vj}		- 40 ... + 130	°C
T_{stg}		- 40 ... + 125	°C
V_{isol}	a. c. 50 Hz; r.m.s.; 1 s / 1 min.	3600 / 3000	V~
M_s	to heatsink	5 ± 15 % ¹⁾	Nm
M_t	to terminal	3 ± 15 %	Nm
a		5 * 9,81	m/s²
m	approx.	95	g
Case	SKKT	A 46	
	SKKT ...B	A 48	
	SKKH	A 47	



SKKT

SKKH

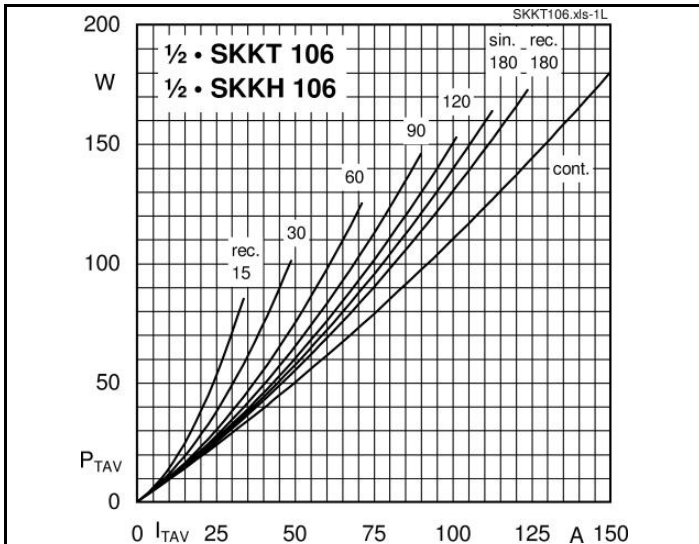

Fig. 1L Power dissipation per thyristor vs. on-state current

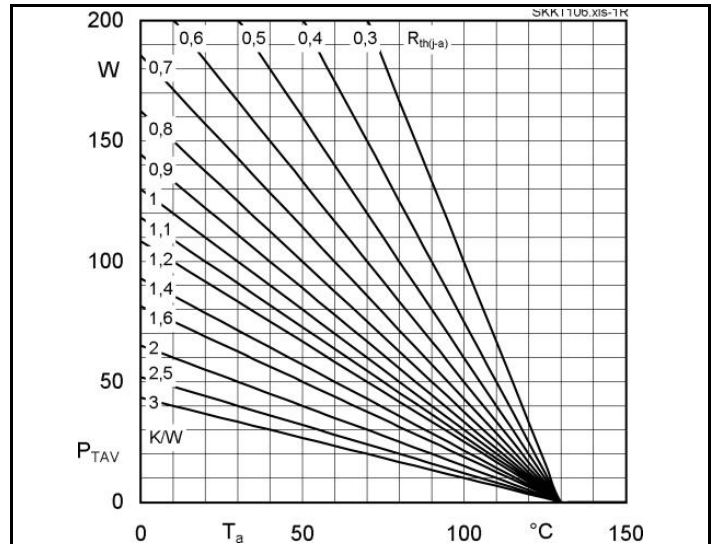

Fig. 1R Power dissipation per thyristor vs. ambient temp.

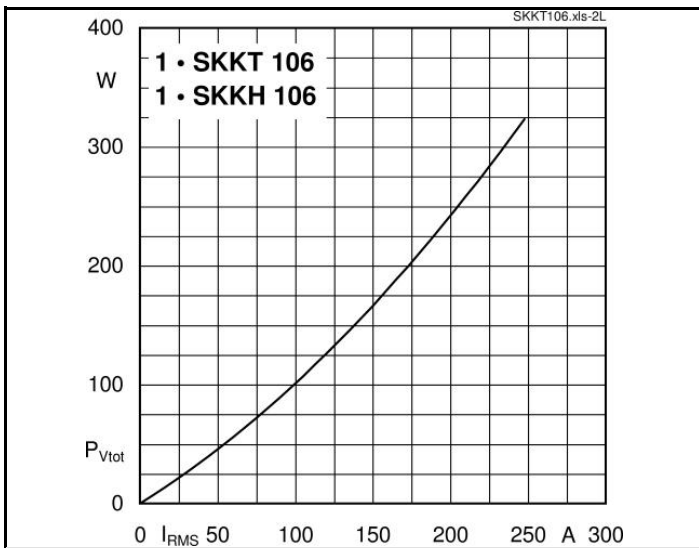

Fig. 2L Power dissipation per module vs. rms current

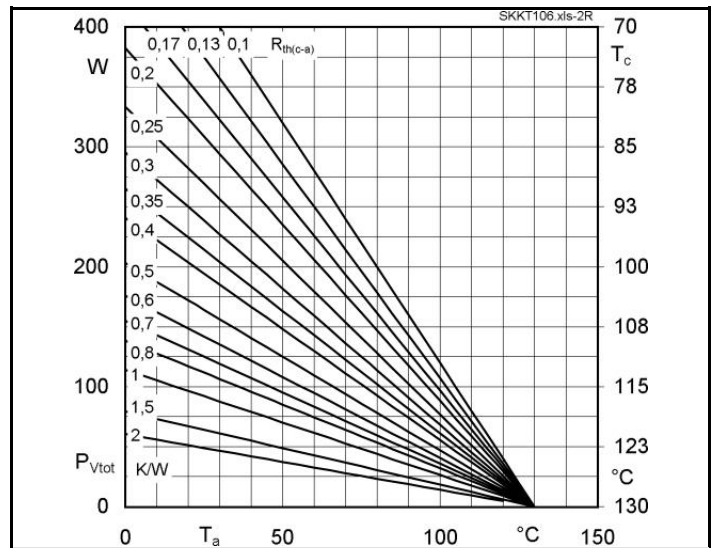

Fig. 2R Power dissipation per module vs. case temp.

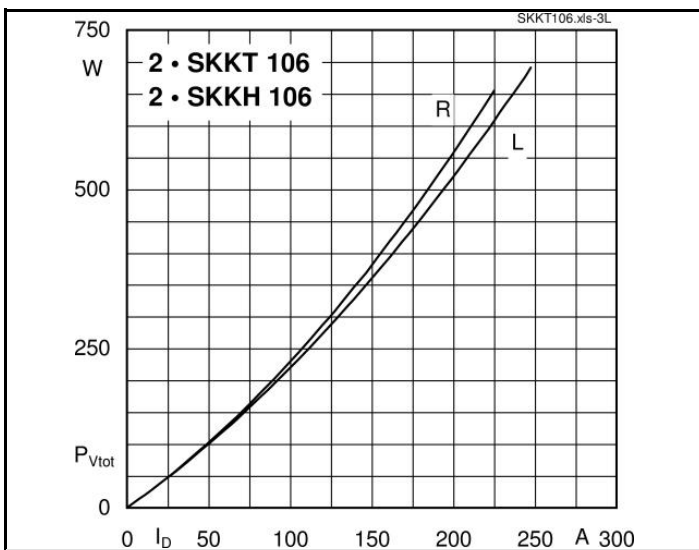

Fig. 3L Power dissipation of two modules vs. direct current

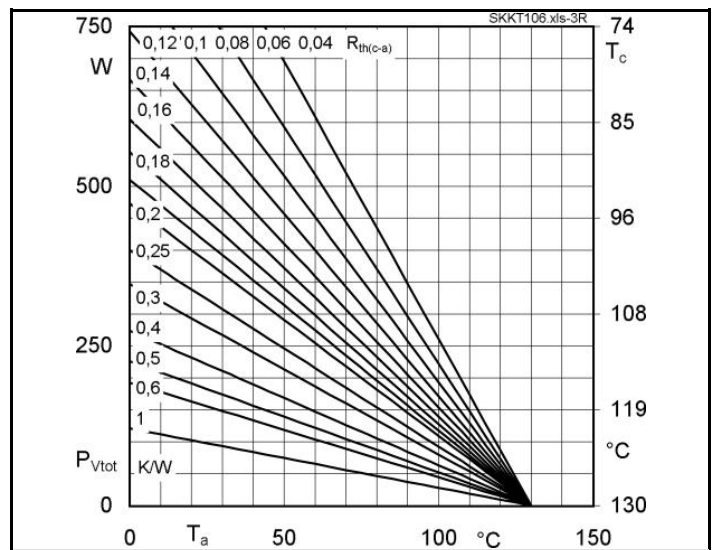
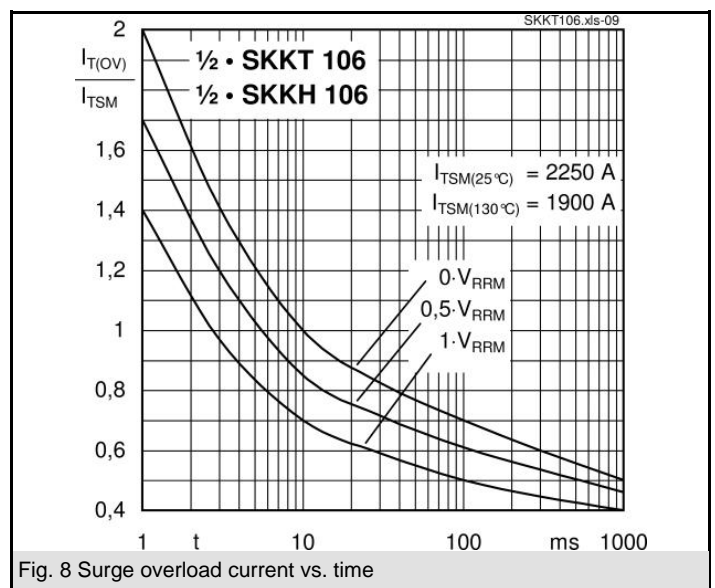
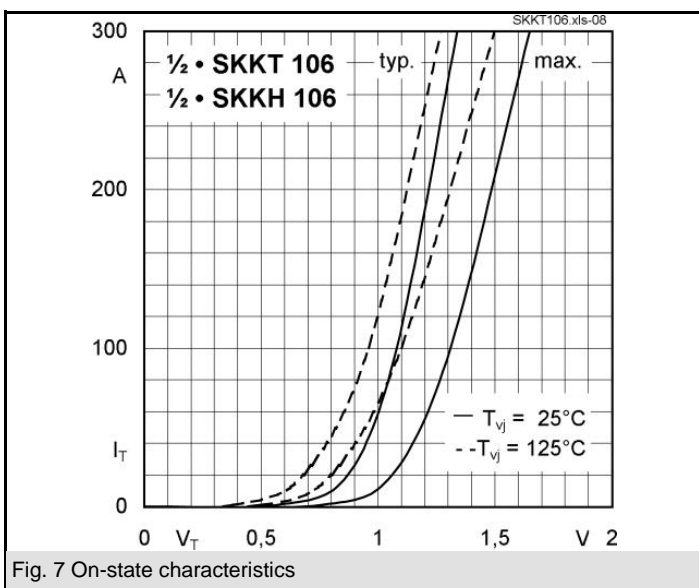
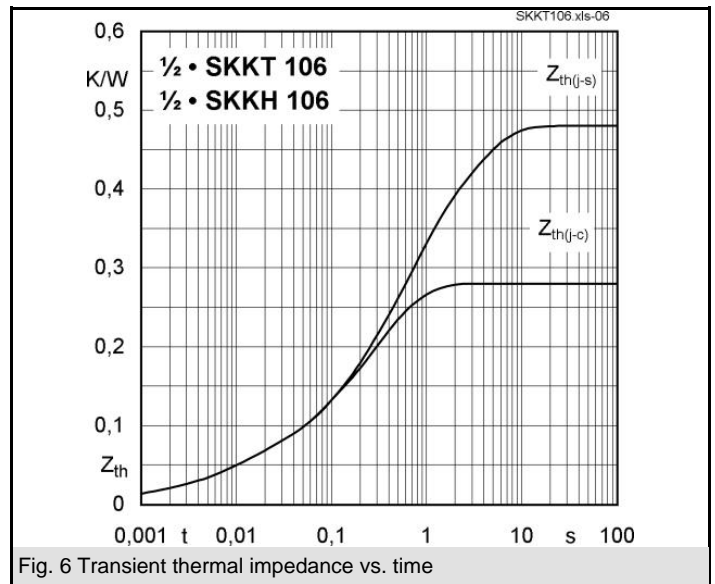
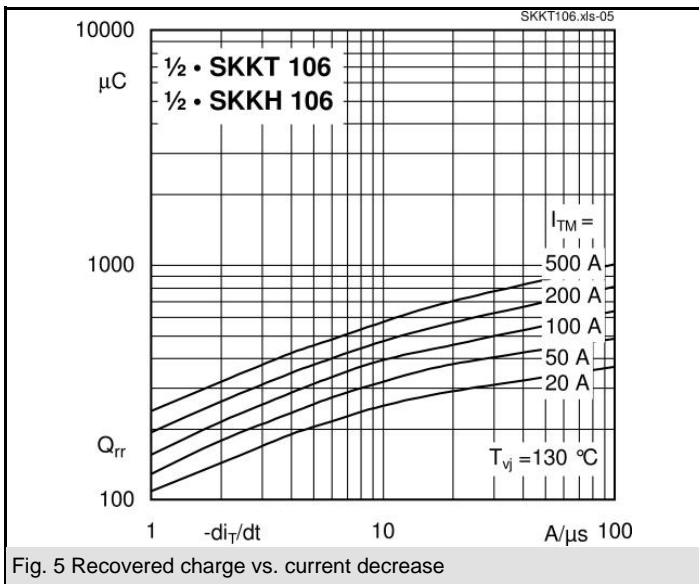
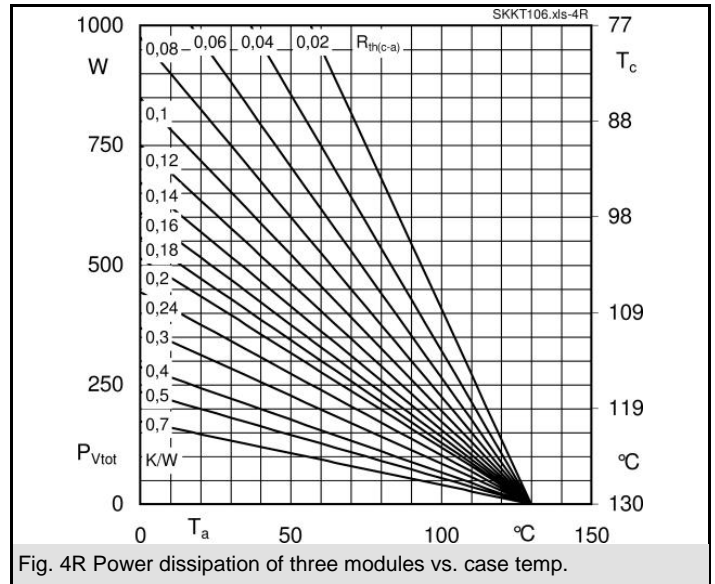
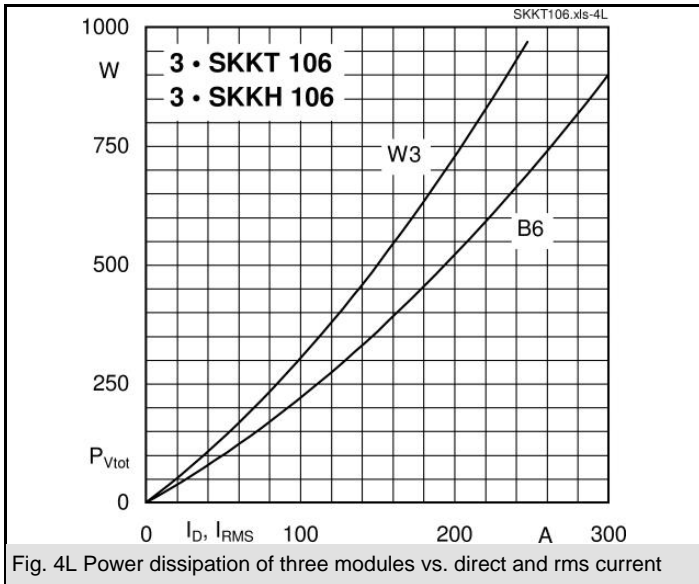

Fig. 3R Power dissipation of two modules vs. case temp.

SKKT 106, SKKT 106B, SKKH 106



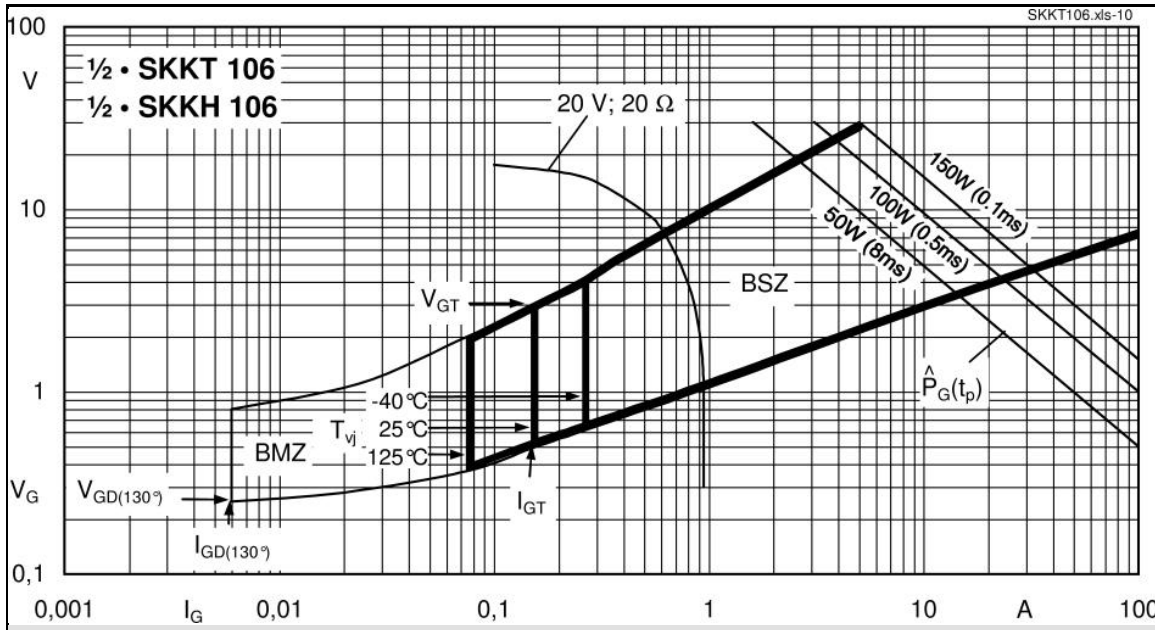
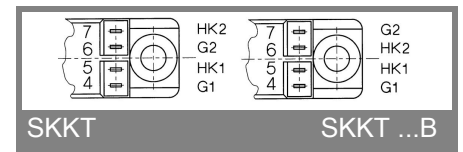
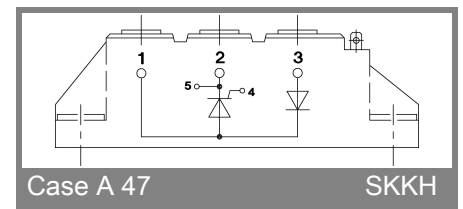
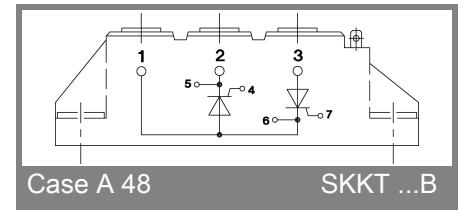
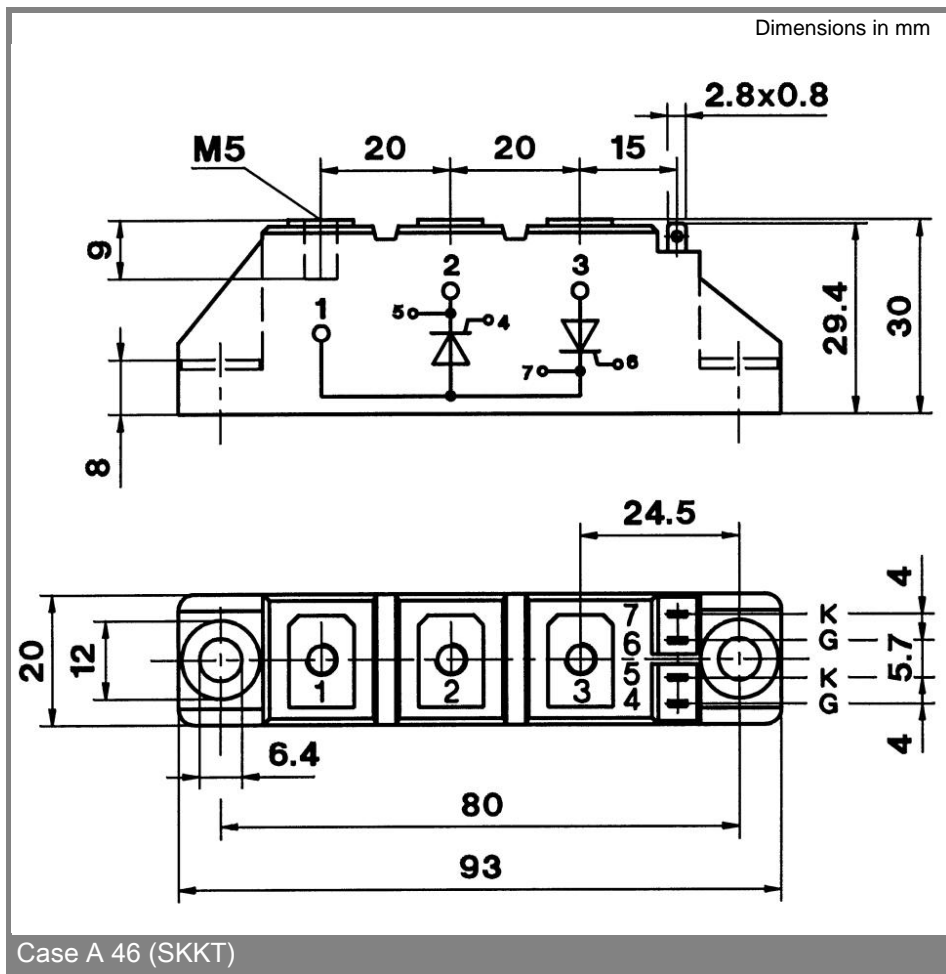

Fig. 9 Gate trigger characteristics



* The specifications of our components may not be considered as an assurance of component characteristics. Components have to be tested for the respective application. Adjustments may be necessary. The use of SEMIKRON products in life support appliances and systems is subject to prior specification and written approval by SEMIKRON. We therefore strongly recommend prior consultation of our personal.